

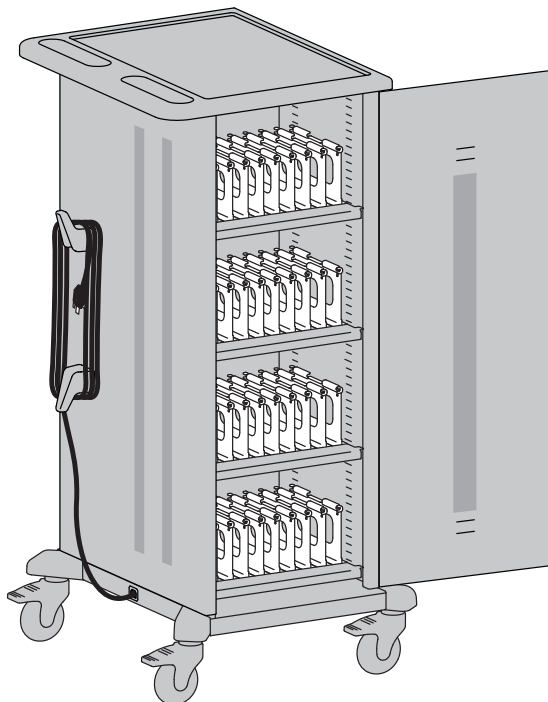





YES 40 Charging Cart

For Tablets

Includes PowerShuttle™ Technology

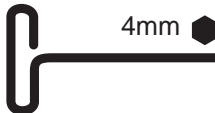

Components

A		B		C		D	
 1	2x 	1x 	4mm 	1x 	40x 		

This cart is designed to automatically charge and store 1-40 tablet, smart phone, and hand held devices safely and efficiently. Adjustable shelves customize shelf height in 2/3" (1.7 cm) increment to fit a range of device heights; adjustable bays slide left to right to fit even the largest cases.

Please review this manual before installing your equipment to learn how to use the cart safely. The cart is listed to UL 62368-1 Audio/Video Information and Communication Technology Equipment.

AC input: 120V~ 60-Hz. Max amps: 12A.

Table of Contents

Safety	2-3
Features & Specifications	4
Set up	5-7
How to Adjust Bay Width	8
How to Adjust Shelf Height	9
Specifications	10
Cleaning & Maintenance	11
Troubleshooting	11





 For the latest User Installation Guide please visit: www.ergotron.com
English, Español, Français

www.ergotron.com | USA: 1-800-888-8458

Safety

Hazard Symbols Review

These symbols alert users of a safety condition that demands attention. All users should be able to recognize and understand the significance of the following Safety Hazards if encountered on the product or within the documentation. Children who are not able to recognize and respond appropriately to Safety Alerts should not use this product without adult supervision!

Symbol	Signal Word	Level of Hazard
	INSTRUCTIONS	Refer to instruction manual/booklet. Follow instructions for use.
	CAUTION	A CAUTION indicates either potential damage to hardware or loss of data and tells you how to avoid the problem.
	WARNING	A WARNING indicates either potential for property damage, personal injury, or death.
	DANGER	A DANGER indicates a hazardous situation that, if not avoided, will result in death or serious injury.

Equipment Electrical Safety

There are specific risks associated with the use of equipment having power cables. You must be aware of, and avoid these risks when the Cart is located in close proximity to children.

 **WARNING:** Failure to observe the following Electrical Safety notices can result in fire or death by electric shock.

Electrical cables can be hazardous. Misuse can result in fire or death by electrical shock.

- Double Pole / Neutral Fusing
- Inspect power cables thoroughly before each use.
- Do not use cables that are damaged.
- Insert the plug completely into the outlet.
- Grasp the plug to remove from the outlet.
- Do not unplug by pulling on the cable.
- Do not use excessive force to make connections.
- Do not plug the cable into an extension cable.
- Do not remove, bend or modify any metal prongs or pins of cable.
- Do not drive, drag or place objects over the cable.
- Do not walk on the cable.
- Avoid overheating. Uncoil the cable and do not cover it with any material.
- Do not run cable through doorways, holes in ceilings, walls or floors.

Keep the Cart away from water.

- Do not use it when wet.
- Do not place the Cart in close proximity to flammable liquids or gases.

 **CAUTION:** The power disconnect for this equipment is the AC power cable. Therefore the socket outlet should be easily accessible and should be installed near the equipment.

Electrical devices are not toys. Children are often unaware of the hazards associated with electrical devices, so this unit must always be used by adults or with adult supervision.

Do not use this unit outdoors.

Liquids should not be stored in, set on or placed inside this unit.

Never unplug this product from the outlet when your hands are wet.

Do not use power cord to pull the cart.

Ergotron does not accept any liability for damage if the unit is misused, incorrectly operated or inadequately repaired. Under these circumstances the warranty will be void.

Safe Use Recommendations

 **WARNING:** Failure to observe the following Cart Use Safety notices may result in serious personal injury or equipment damage.

 **WARNING:** Death or serious injury may occur when children climb on audio and/or video equipment furniture. A remote control or toys placed on the furnishing may encourage a child to climb on the furnishing and as a result the furnishing may tip over on to the child.

 **WARNING:** Relocating audio and/or video equipment to furniture not specifically designed to support audio and/or video equipment may result in death or serious injury due to the furnishing collapsing or over turning onto a child.

Elevated Operating Ambient - Consideration should be given to installing the cart in an environment compatible with the maximum ambient temperature T_{ma} of 30 degrees C.

Reduced Air Flow - Instructions indicated to not block the ventilation openings so proper air flow required for safe operation of the equipment is not compromised.

Mechanical Loading - Mounting of the equipment in the cart should be such that a hazardous condition is not achieved due to uneven mechanical loading.

Only Adults should move this cart.

- Do not allow anyone to sit, stand, or climb on the Cart.
- Do not block the vent openings. To prevent overheating, leave at least 127 mm (5-inch) clearance around vents.
- The Cart is designed to be used indoors only.
- Do not use the Cart to transport or store equipment other than what has been noted in this guide.
- The maximum weight capacity of the top surface is 11.4 kg (25 lb).
- The maximum weight capacity per shelf is 28 lbs (12.7 kg) (4 shelves total)

 **CAUTION:** DO NOT EXCEED MAXIMUM LISTED WEIGHT CAPACITY. SERIOUS INJURY OR PROPERTY DAMAGE MAY OCCUR!

Moving the Cart

- Before moving the Cart:
 1. Disconnect the power cable from the wall.
 2. Disconnect Ethernet cable from the wall if present.
 3. Make sure the cable is wrapped and secure.
 4. Close and lock the doors.
 5. Remove loose items from the top work surface.
 6. Unlock the casters.
- Push (do not pull) the Cart for optimum maneuverability and to prevent muscle strain.
- Do not move the Cart across rough, uneven or irregular surfaces such as gravel.

Parking the Cart

Observe these safety alerts for times when the cart is stationary:

- Do not park the Cart in areas of heavy traffic.
- Do not run cables across hallways, classrooms, or other areas where they will be walked on.
- Do not leave Cart unattended in areas where children have access.
- Keep Cart doors closed and locked whenever it is unattended or parked for charging or storage.
- Keep Cart casters locked whenever it is unattended.

Charging

DEVICES MUST BE TURNED OFF BEFORE CHARGING. Failure to follow these instructions may result in overheating.

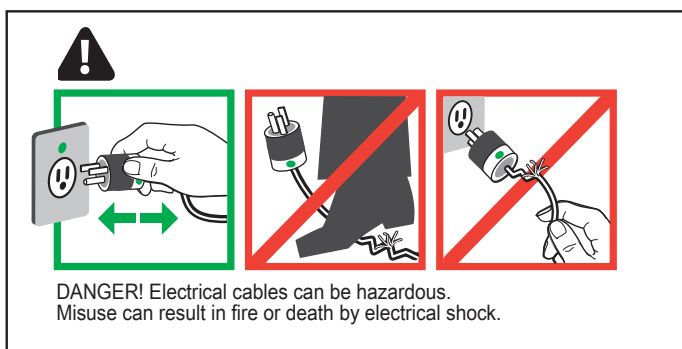

Features & Specifications

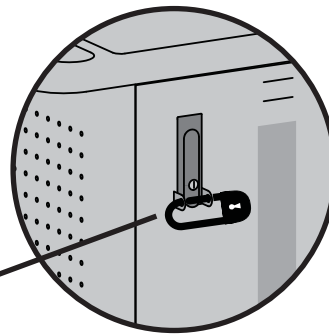
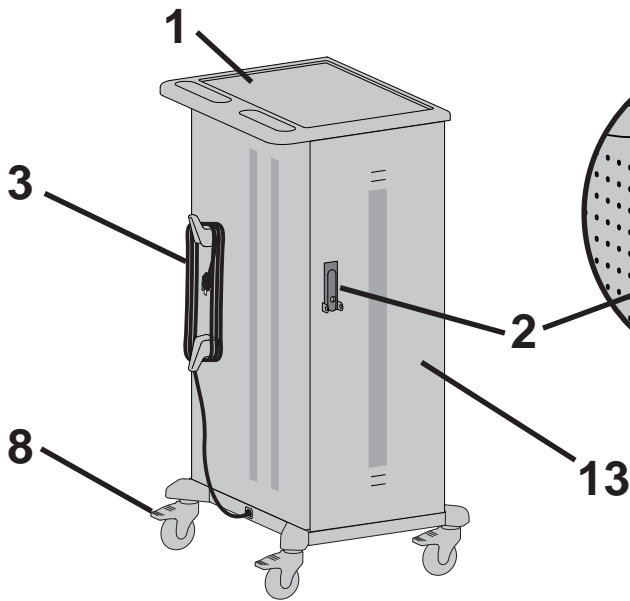

For added security, each door features hasps to hold your own padlock (maximum shackle dia 5/16" (0.8 cm); minimum shackle height 2" (5.1 cm)). When installed, your padlock restricts access to the handle so the unit can't be opened.

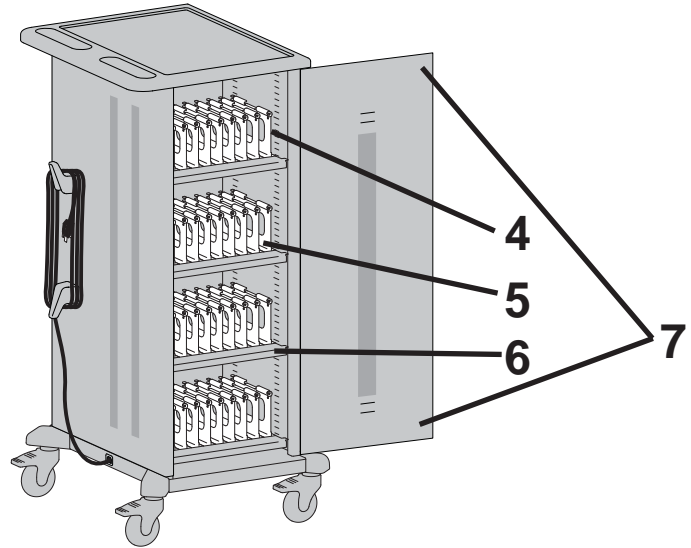
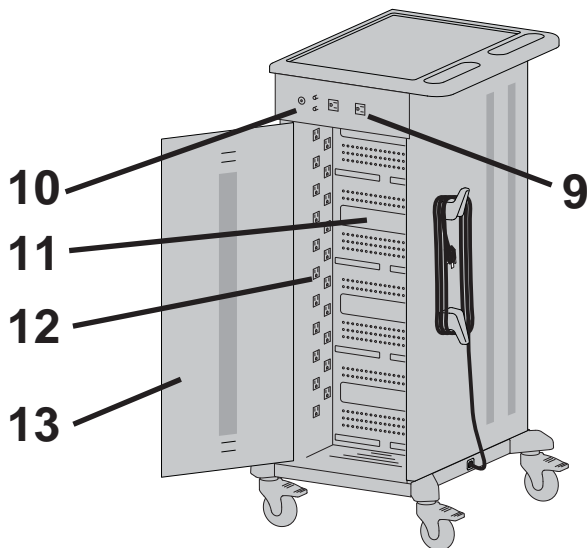

1. Top shelf with 1/4" h (0.6 cm) lip and Handle
2. Locking door latch w/padlock bracket*
3. Cord wrap w/9' 8" (3 m) power cord
4. Device bays w/width adjustment
5. Bay dividers w/cable channels
6. Shelves w/height adjustment
7. Two-point locking system*

8. 4" (10 cm) total-lock casters
9. External power receptacles**
10. Power button w/indicator light
11. Center panel w/cord pass-through openings
12. Internal power receptacles***
13. Two removable doors open 270°

*Doors and Locks

The doors on the cart feature a two-point keyed locking system to protect your devices. To open a door, lift the bottom of the handle and rotate it to the inside of the unit. Your cart shipped with 2 keys. Contact Customer Care for replacements.

**External Power

This Cart comes with 2 power receptacles on the side of the cart. When the power cord is plugged in and the power button is on, these receptacles receive power. Power to these receptacles takes precedence over power to charge the devices. Charge time for devices will be impacted.

***Internal Power

When the power cord is plugged in and the power button is on, power is directed to the receptacles in the IT area.

Make sure cart is unplugged from the wall before starting set up.

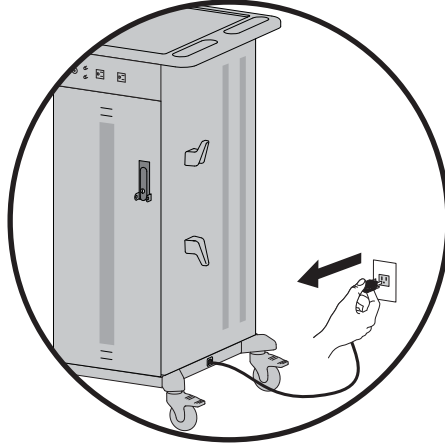

1 Open doors.

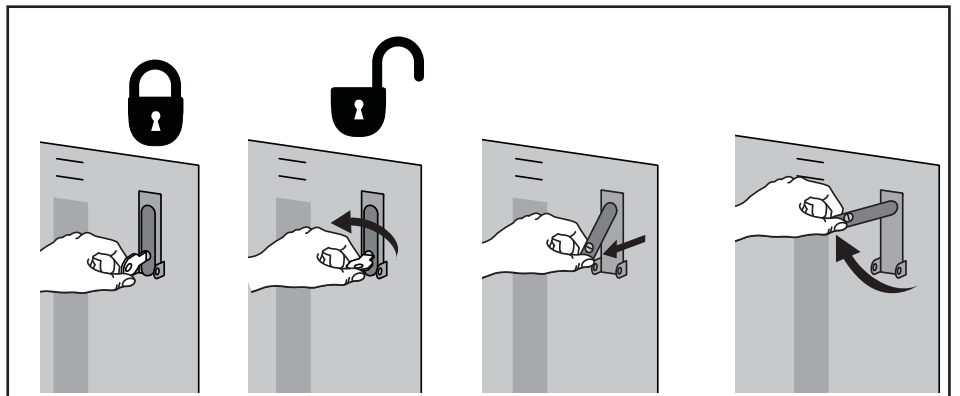
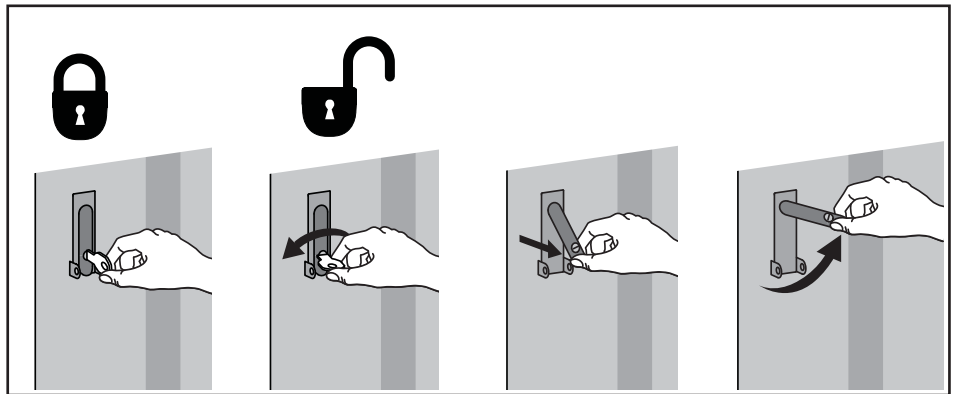
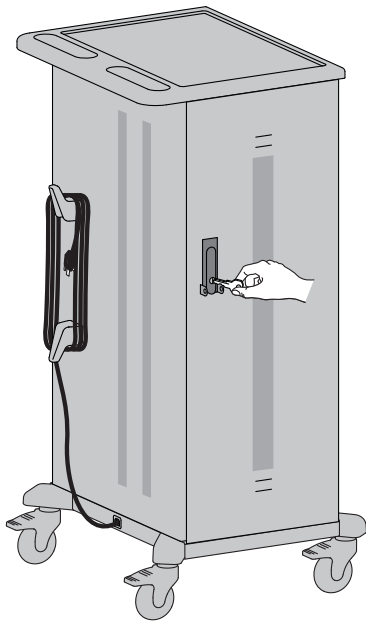

2 Route cables.

a

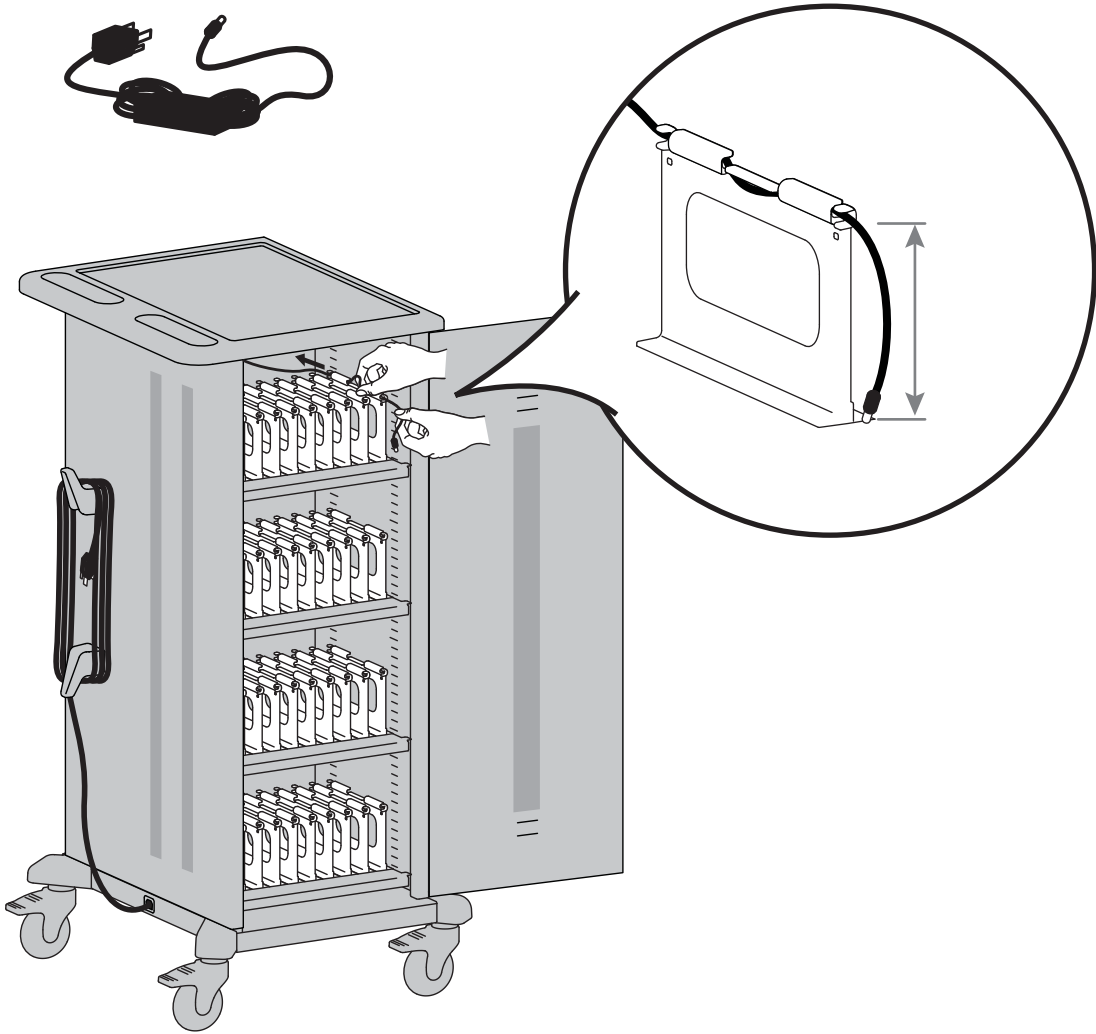

b

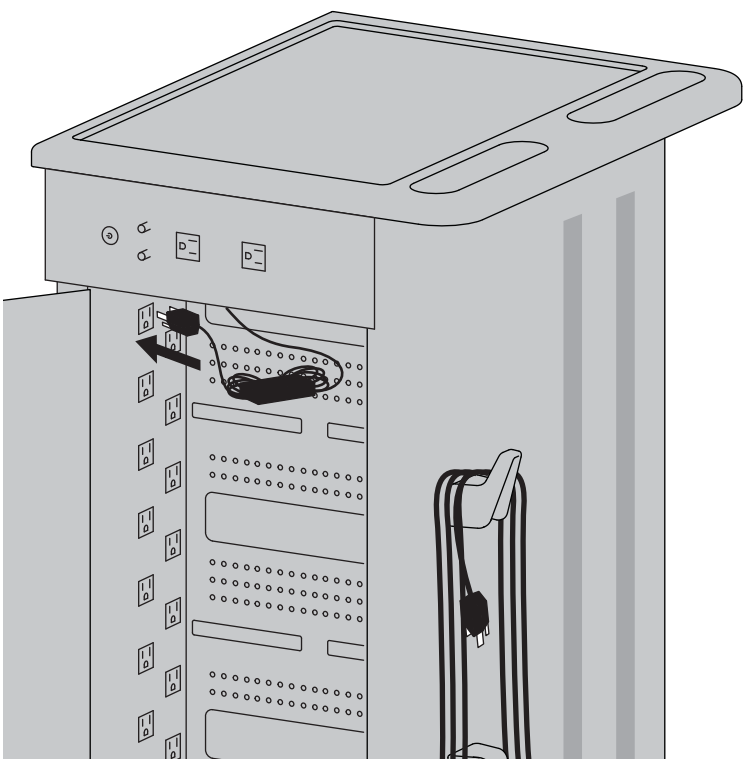

c

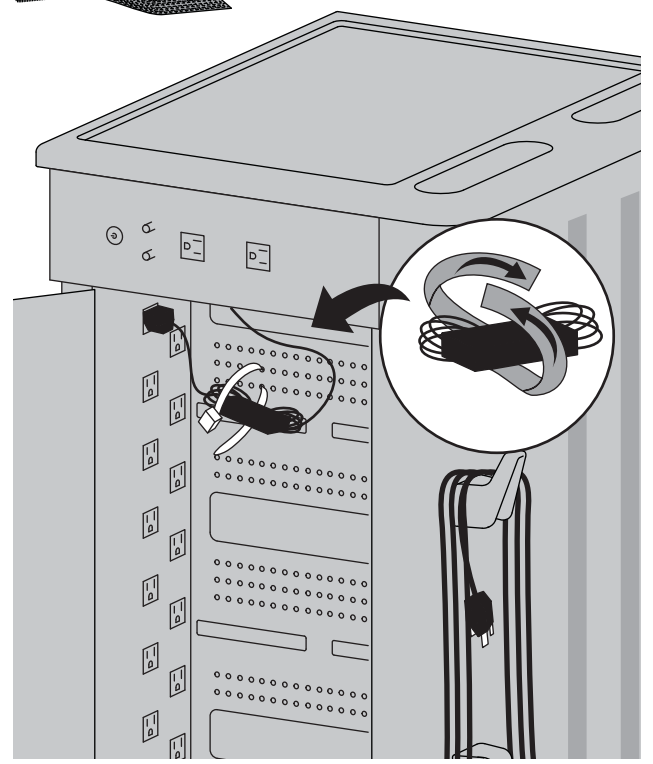

3 Add the Bay labels to each Bay

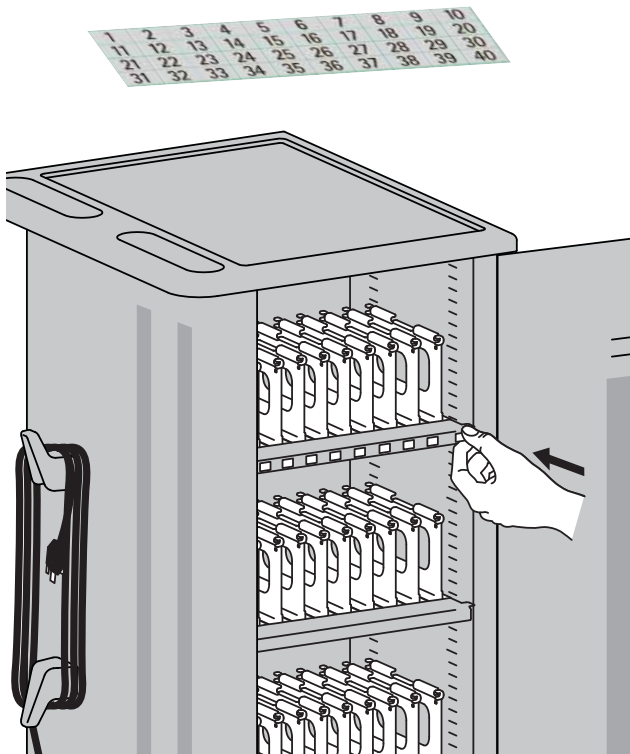

4 Plug in and insert devices.

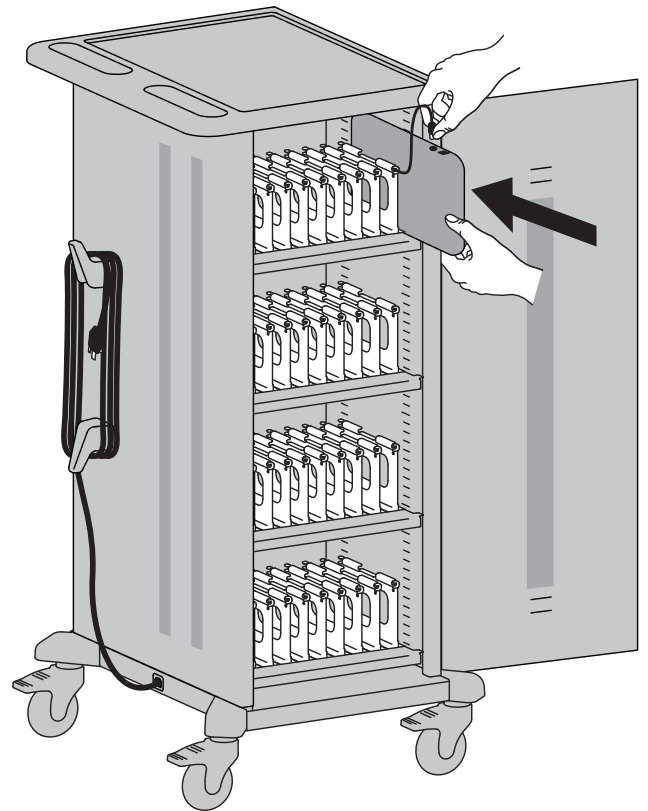

5 NOTE: ALL DEVICES MUST BE TURNED OFF BEFORE CHARGING. Failure to follow these instructions may result in overheating.

To charge devices, plug in power cord and turn cart power on.

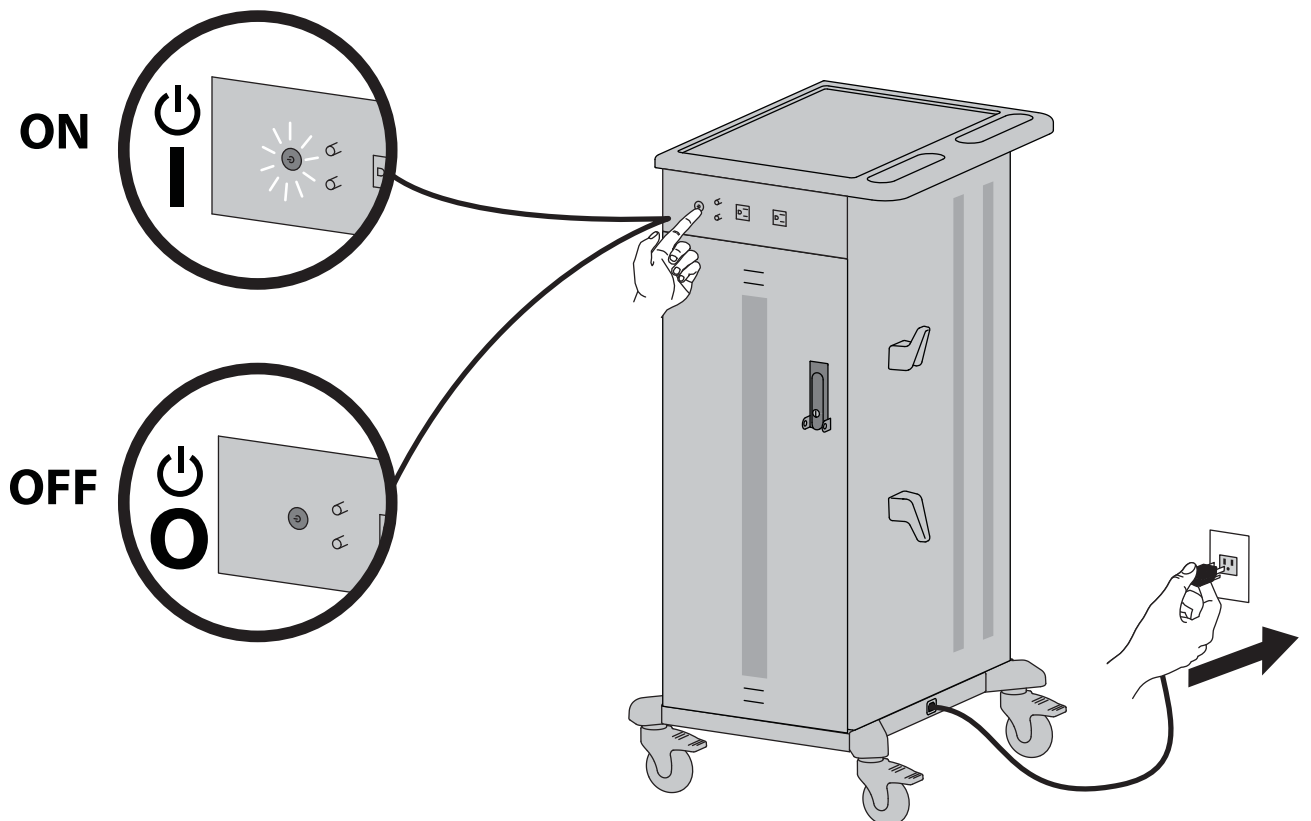

How to Adjust Bay Width:

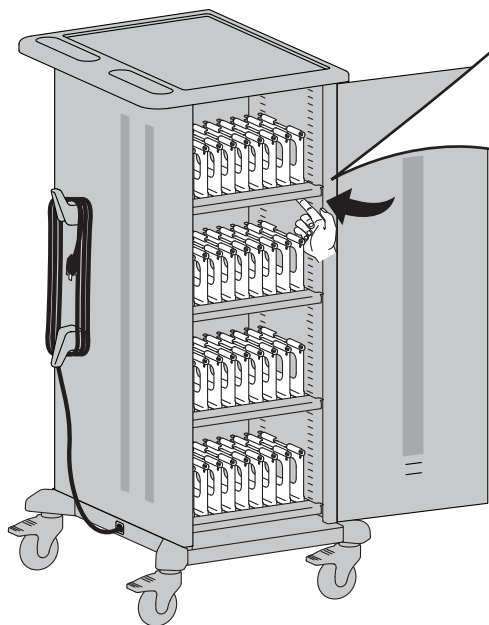

Remove Divider

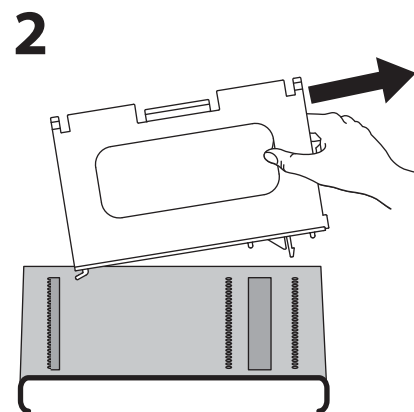
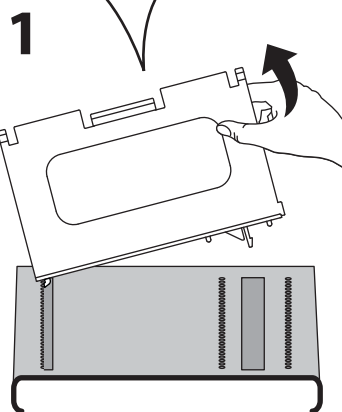
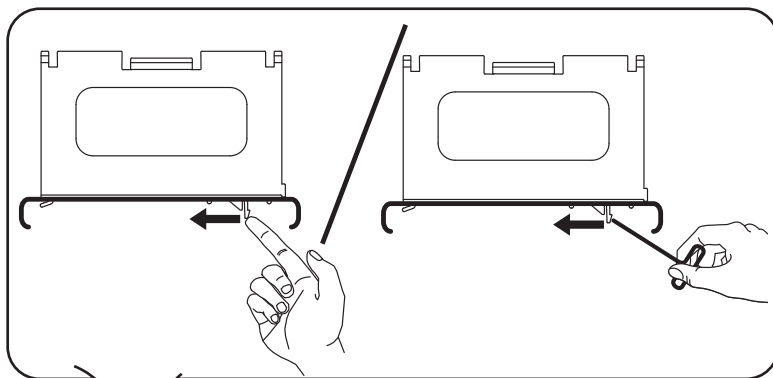

Install Divider

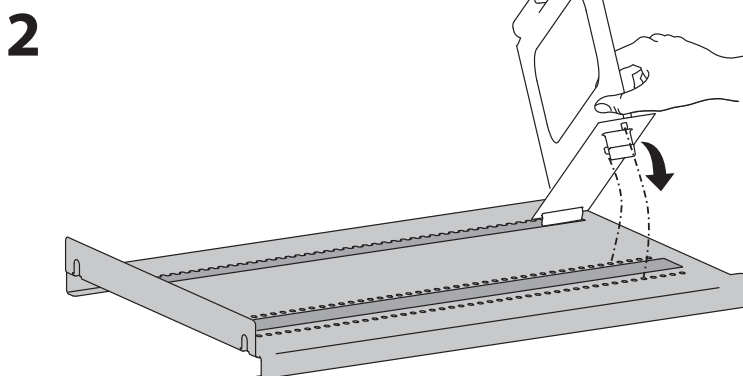
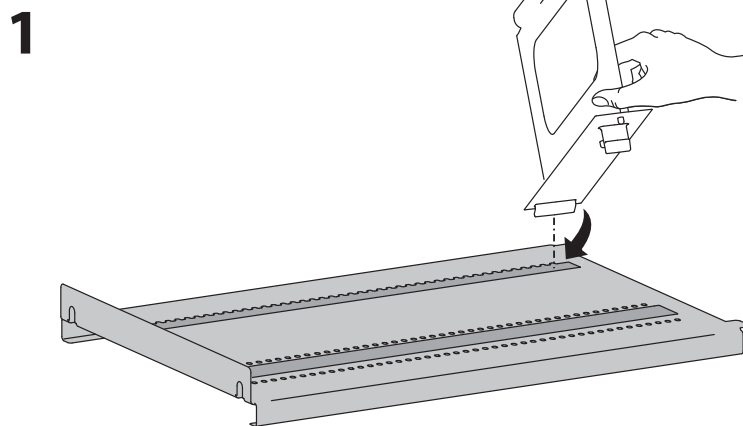

How to Adjust Shelf Height:

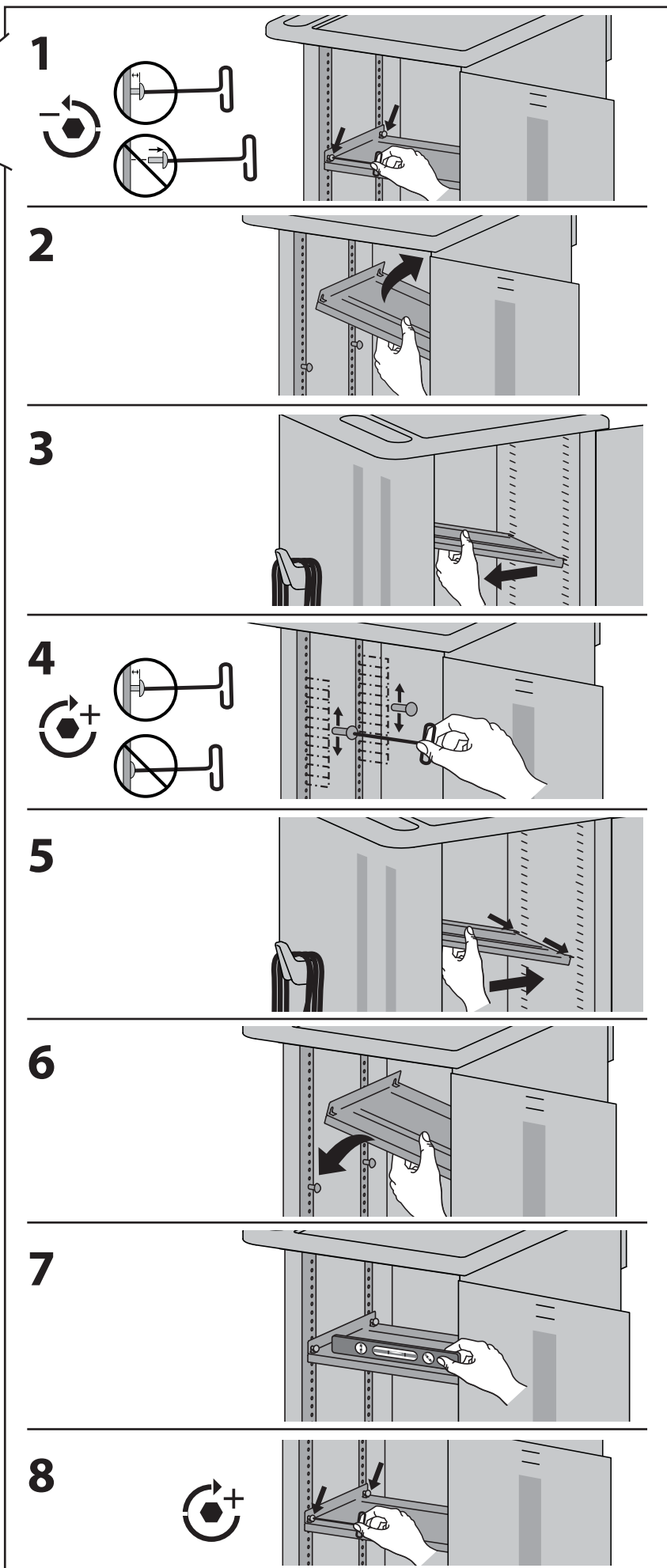
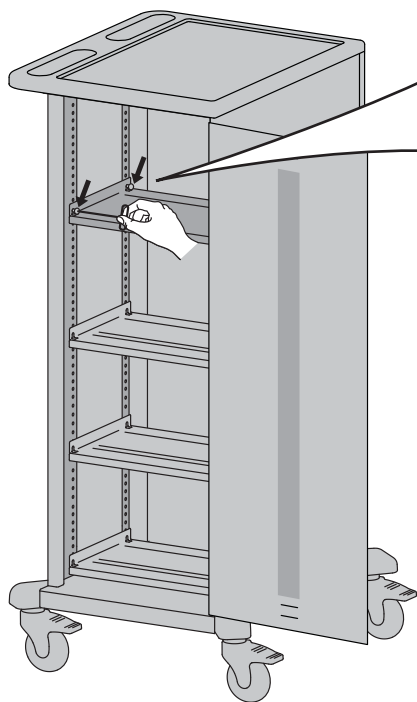

Specifications

Operation is subject to the following two conditions:

- 1) This device may not cause harmful interference.
- 2) This device must accept any interference received, including interference that may cause undesired operation.

Changes or modifications not expressly approved by Ergotron could void the user's authority to operate the equipment.
Intended for institutional use.

Cart dimensions

24.5"W x 46"H x 23.75"D (62x117x60 cm)

Cart weight (without equipment)

136 lb (61.7 kg)

Rated weight capacity

Top Work Surface

25 lb (11.4 kg)

Device Slot Size (for 40 Slot set up)

1.3"W x 10.5"D x 10"H (3.4x26.7x25.4 cm)

Device with case and power cord installed must fit within these dimensions.

External power outlet(s)

2 outlets

120V~ 60-Hz, 3A

Shipping dimensions

34"W x 53"H x 32"D (86x135x81 cm)

Shipping weight

193 lb (87.5 kg)

Power system

120V~ 60-Hz, 12A

Maximum input for four devices cannot exceed 10A

Environmental

Temperature range:

Operating 59° to 86°F (15° to 30°C)

Storage -40° to 140°F (-40° to 60°C)

Relative humidity (maximum):

Operating 10%–90% (non condensing)

Storage 5%–95% (non condensing)

Altitude (maximum): 2000 m (6,562 ft)

Certification:

UL 62368-1 Audio/Video Information and Communication Technology Equipment.

CAN/CSA C22.2 No. 62368-1-14

ICES-003 Issue 6, Class A

FCC Part 15 Class A

RoHS and REACH compliant material used.

Cleaning and Maintenance

-  **WARNING:** Failure to observe the following safety notices may result in serious personal injury or equipment damage. Inspect for damage, dirt and debris on a regular basis. All paint and plastic components used in the Cart will withstand cleaning by most commonly used, diluted, non-abrasive solutions such as quaternary ammonia compounds, ammonia enzyme cleaners, bleach, or alcohol solutions. It is recommended that any cleaning solution be tested on a small, inconspicuous area to ensure it does not harm the surface of the Cart.
- Marks from permanent marker, dry-erase marker, and pens can be removed with 91% isopropyl alcohol and a soft cloth.
 - Iodine stains can be removed with commonly used cleaners and a soft cloth.
 - Do not use steel wool or other abrasive materials that may damage the surface finish.

 **WARNING:** To avoid risk of electric shock, do not expose electrical components to water, cleaning solutions or other potentially corrosive liquids or substances.

 **WARNING:** Do not immerse Cart or Cart components in liquid or allow liquids to flow into the Cart. Wipe all cleaners off surface immediately using a damp cloth. Dry the surface thoroughly after cleaning.

 **WARNING:** Do not use flammable cleaners on Cart surfaces.

 **CAUTION:** Adjustment, Service, Replacement - DO NOT attempt to adjust, service or replace any part of the Cart unless directed to do so through Ergotron-approved documentation (i.e. installation instructions). Only Ergotron, Inc. or an Ergotron-certified entity may adjust, service or replace Cart components. If any component on the Cart is missing or damaged, the Cart must not be used. Contact Ergotron immediately to request a replacement part.

 **CAUTION:** Casters - Check casters periodically to make sure they are clean and free of debris that would prevent smooth travel. Avoid moving Cart across uneven, dirty, or damaged surfaces.

 **CAUTION:** Customer Equipment- Make sure equipment is balanced and installed securely to Cart. Contact Ergotron for information about moving Cart components.

Troubleshooting

The blue power button is flashing. What does that mean?

There is an over-current condition that cannot be resolved. Power has been removed to the devices. An over-current condition could be a defective device installed or possibly something plugged into external auxiliary outlet causing too much current. To correct, remove source of over-current condition, then unplug from wall and then plug back in, or push power button OFF then back ON to reset. If you cannot determine which device is causing the over-current condition, unplug all devices, turn cart on and plug in one device at a time to determine which device is causing the over-current condition.

The devices are all plugged in, but they won't charge. What do I do?

Make sure power cord is plugged into cart and a working wall outlet, and power button is pushed in, to turn on, and illuminated blue. Next, check the cart: Is the blue power button flashing? See steps above. If not, is the power button illuminated blue when pushed in? If not, disconnect the main power cord from the wall and inspect the cord and plug to make sure that they're undamaged. Plug the cord into a working power outlet. Next, check the devices: Verify that each device is connected to its power adapter and that each adapter is plugged into the internal outlet. Look at the circuit breakers located on the external outlet panel, if one of the circuit breaker buttons is extended out, call customer care to assess the state of the internal power system. If circuit breaker buttons are both set in, push the power button to power up the outlets. Still need some help? Call Ergotron at 800-888-8458.

Someone tried to break into the unit and damaged a door. Can it be replaced?

Yes, you can order a replacement. Contact Customer Care. We'll ask you for the model number of your cart and whether it's for the front or back of the unit.

My power cord/plug is damaged. Is it covered under warranty?

For warranty information, visit: www.ergotron.com/warranty

When I plug in the unit it trips the circuit breaker. What is wrong?

The carts are designed to run on a 15 amp circuit. If you have other equipment or appliances plugged into the same circuit you may be overloading it. Have a qualified electrician check that adequate power is available in the circuit.

My unit was damaged during shipment. What should I do?

Please contact Customer Care at 800-888-8458.

How do I find the unit's serial number?

The serial number label is inside the IT compartment on the base.

Can I remove a bay divider?

Yes! To move the dividers and adjust the bay width, press back on the flat tab under the shelf that connects the divider to the shelf until the divider pops free. If your fingers don't fit, try a flat-head screwdriver. To install the divider, angle the divider into a slot at the back of the shelf, then tilt the divider into place at the front of the shelf.

For Warranty visit: www.ergotron.com/warranty

For Service visit: www.ergotron.com

For local customer care phone numbers visit: <http://contact.ergotron.com>

NOTE: When contacting customer service, reference the serial number.

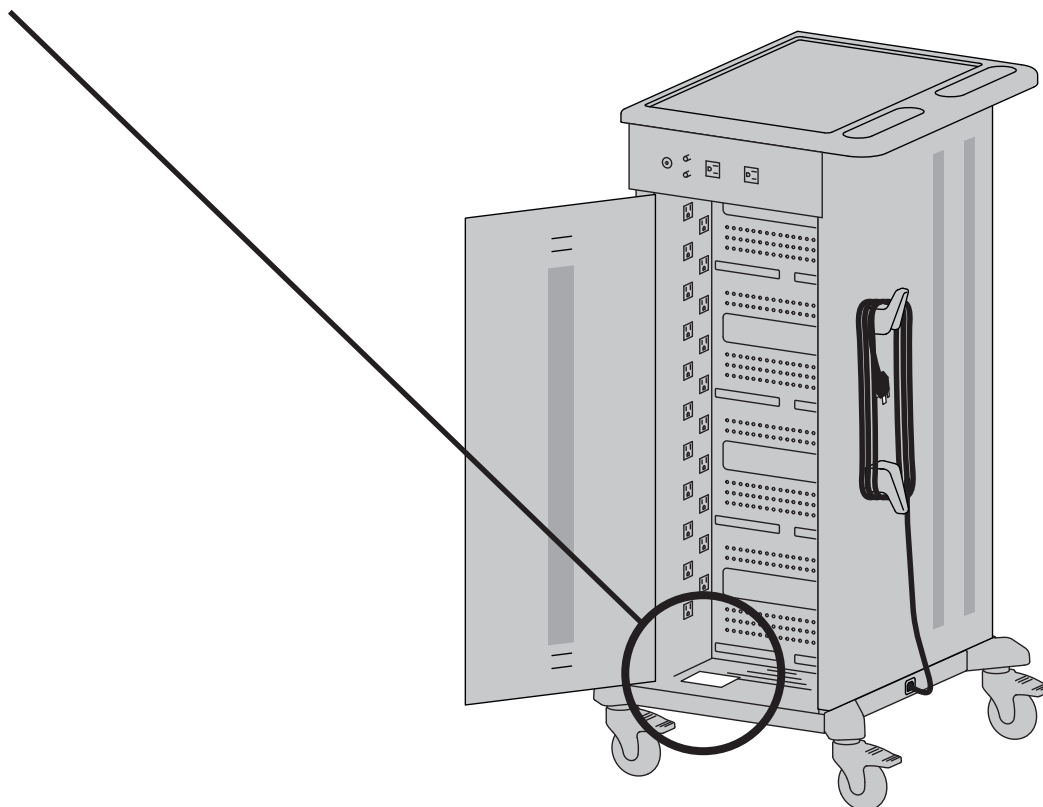

ergotron®

www.ergotron.com | USA: 1-800-888-8458

© 2015 Ergotron, Inc. All rights reserved. PowerShuttle™ is a registered trademark of Ergotron, Inc.

While Ergotron, Inc. makes every effort to provide accurate and complete information on the installation and use of its products, it will not be held liable for any editorial errors or omissions (including those made in the process of translation from English to another language), or for incidental, special or consequential damages of any nature resulting from furnishing this instruction and performance of equipment in connection with this instruction. Ergotron, Inc. reserves the right to make changes in the product design and/or product documentation without notification to its users. For the most current product information, or to know if this document is available in languages other than those herein, please contact Ergotron. No part of this publication may be reproduced, stored in a retrieval system, or transmitted in any form or by any means, electronic, mechanical, photocopying, recording or otherwise without the prior written consent of Ergotron, Inc., 1181 Trapp Road, Eagan, Minnesota, 55121, USA Patents Pending and Patented U.S. & Foreign. Ergotron is a registered trademark of Ergotron, Inc.